

# LucidShape Procedural Surfaces for Lens and Reflector Applications

Paper #006-2

## Author

**Peter Sommer**  
Synopsys

## Abstract

State-of-the-art lighting systems in motor vehicles require new geometries to achieve the required lighting effects. The use of computer-based design in vehicle lighting has made such geometries common. This paper introduces LucidShape's concept of "Procedural Surfaces", which allows you to design complex reflector and lens surfaces from a predefined set of curves. You can customize curve parameters and then use tools to operate on the curves to build 2D and 3D models that conform to your lighting objectives.

## Introducing LucidShape

The construction of proper reflector and lens geometry for a desired lighting is usually a very time-consuming process. A software tool needs suitable mathematical algorithms to help the engineer with design work. What differentiates LucidShape from other tools is that you can design directly by light function rather than by parameter. For example, you can directly specify a function like a spread angle and LucidShape will calculate the shape automatically. A separate pre-calculation of parameters, like a radius for a flute element, is not needed as it would be in a CAD system.

Hand in hand with the design procedure, fast simulation and intelligent analysis features improve the design process. Fast simulation tools that can predict the beam pattern of a whole reflector in a few seconds tremendously speeds up the development cycle and makes small optimization loops possible.

To validate the created geometry of the design, the designer needs additional analysis tools. The interactive ray path display and light source (filament) images in LucidShape give you direct feedback about the behavior of each shape.

LucidShape has been in use over the past 15 years to design lighting for automotive and other lighting applications. The following sections describe how LucidShape software's design features have been used in some of those applications.

# Key Concepts

## Procedural Surfaces

In LucidShape, you can create surfaces by rotating or extruding base curves. This class of surfaces is called procedural. LucidShape provides a rich set of predefined procedural surfaces that can be used to quickly define shape geometry. For example, bowl and trough reflectors are both classical shapes in lighting design. You can use LucidShape’s rotational surface to easily create a bowl reflector and use an extruded surface to create a trough reflector (Figure 3). You can create swept and swung surfaces (Figure 4) to create reflectors or lenses for signal lamps and high beam application.

## Profile Curves

In LucidShape, a profile curve (2D or 3D) consists of a sequence of profile elements. Mathematically, the curve is represented as a NURBS curve. For each profile element an individual lighting feature may be specified, which may be either of reflective or refractive nature. A family of profile elements (which may be arranged in an array) provides many types of lighting functions:

- Freeform 2D or 3D spread curves. The spread can be controlled over a list of spread angles
- Arcs. Each side of which directs the light to two directions, controlled by two spread angles
- Simple spread arcs. For example, a circular arc controlled by one spread angle
- Parabolic and elliptical arcs
- Prisms, which direct the light in one single direction
- TIR prisms, which make use of one or more “Total Internal Reflection” to direct the light

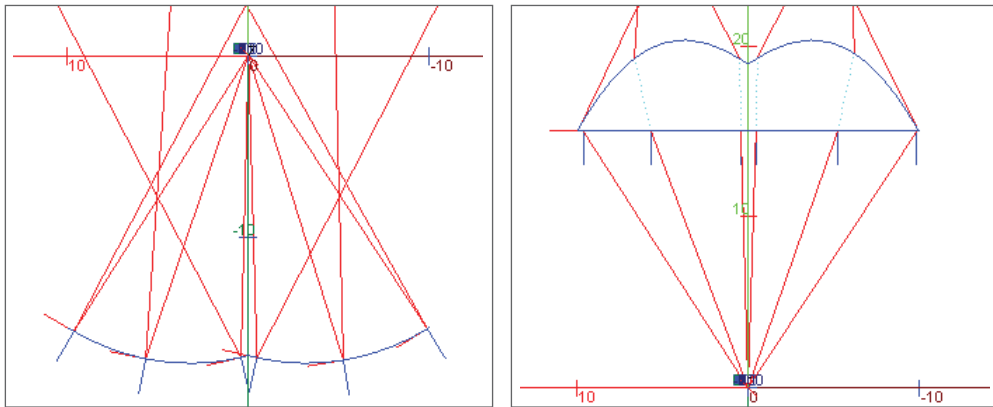

Figure 1: Reflector (left) and refractor (right) profile curve elements

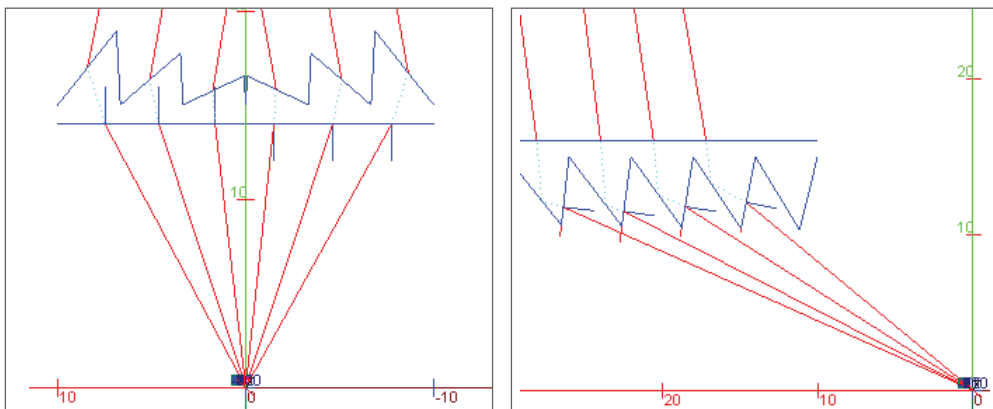

Figure 2: Prism (left) and TIR prism (right) curve

## Procedural Operations

In LucidShape, you can perform these procedural operations using profile curves:

- Extrude a profile curve along a (fixed or variable) direction
- Rotate a curve around an axis, using a fixed (for rotational surfaces) or variable (for swung surfaces) radius
- Sweep a curve along a second curve

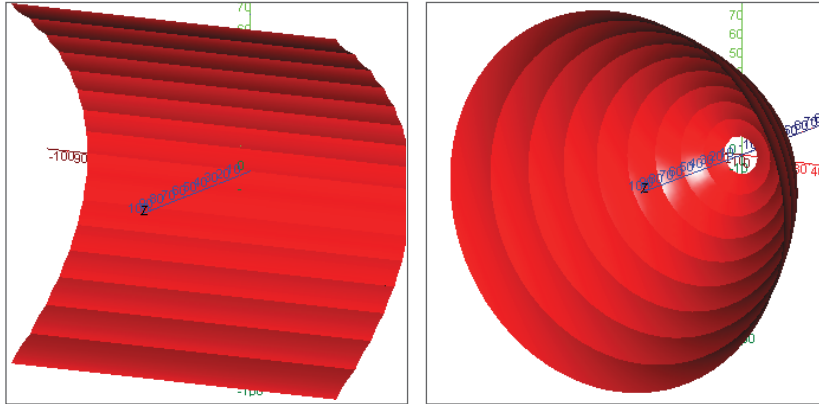

Figure 3: Extruded (left) and rotated (right) surface

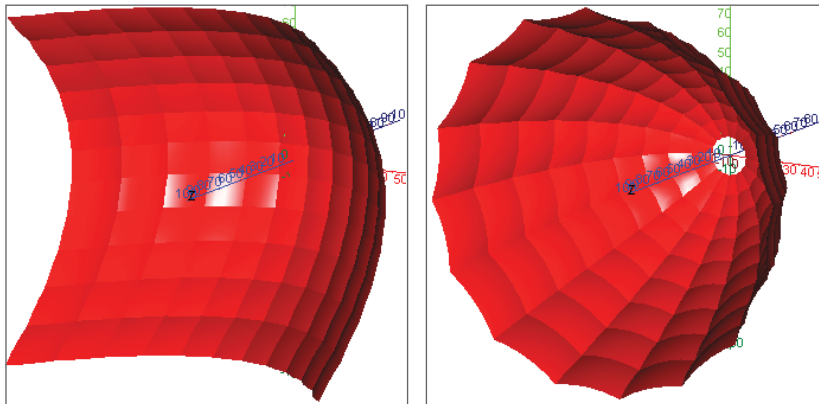

Figure 4: Swept (left) and swung (right) surface

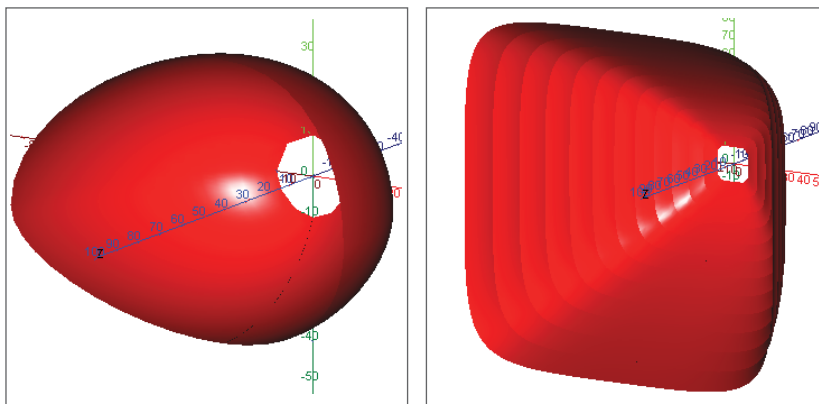

Figure 5: Swung surfaces

## Designing Lens Types with LucidShape

You can use 2D profile curves and procedural operations in LucidShape to create a large variety of lenses, from aspherical to variable freeform lenses.

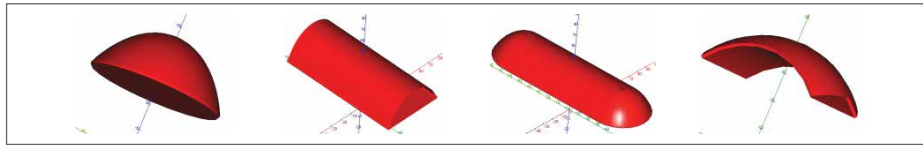

Figure 6: Various aspherical lenses—rotation, extrusion, torus

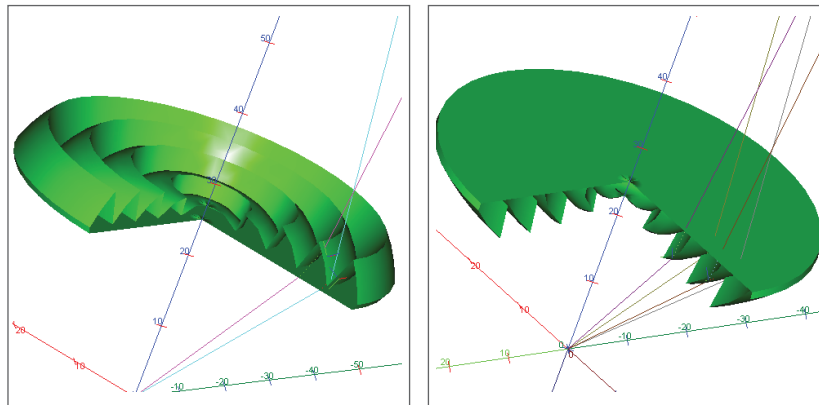

Figure 7: Outer and inner Fresnel lens with individual spread

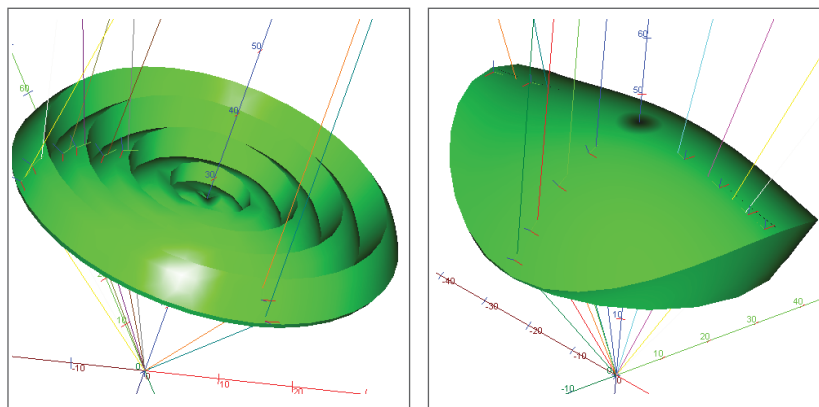

Figure 8: Rotational Fresnel lens and “potato chip” lens with different vertical and horizontal spread

## Procedural Surfaces in Applications

All procedural surfaces may be used in lens or reflector applications. Easy parameterization of the 2D/3D profile curves and the simple surface creation method make it very straightforward to achieve the intended beam pattern.

Lens design for signal lamp application is a typical example. The required spread angles are set for the profile curves.

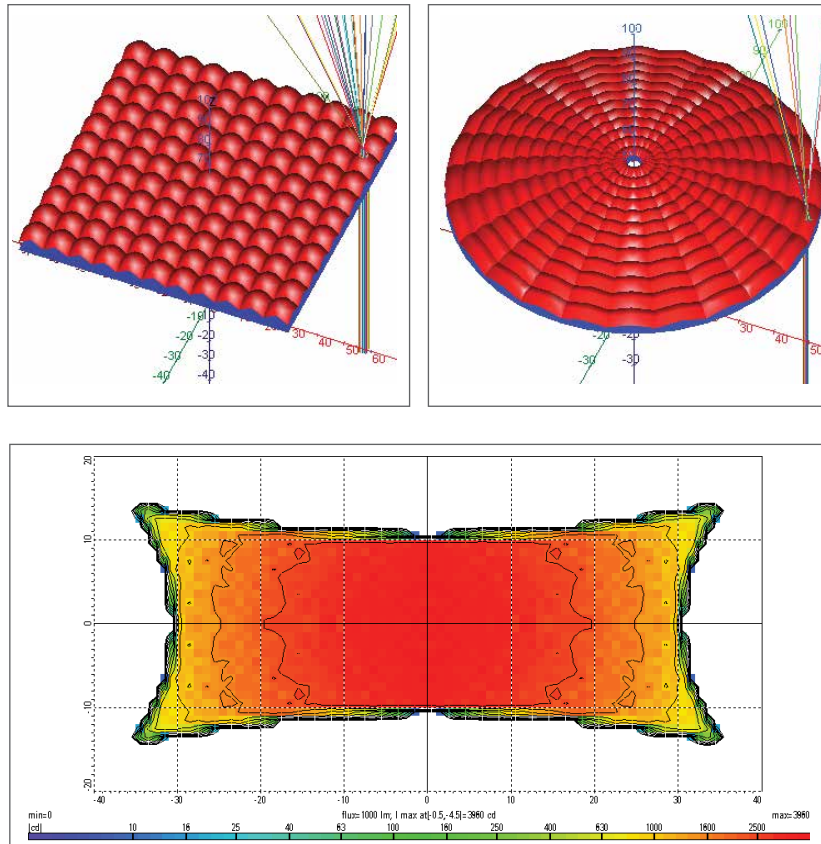

Figure 9: Lens design with procedural surfaces

Variable rotated surfaces (“VaroSurfaces”) are based on several curves. Four individual “north,” “south,” “west,” and “east” curves build a closed surface. The different curves define the vertical and horizontal light spread.

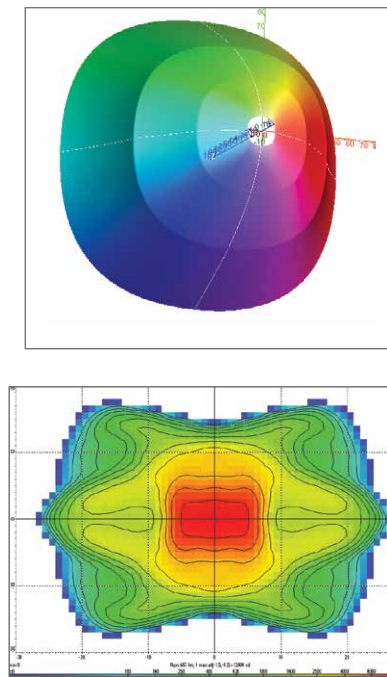

Figure 10: Signal lamp with VaroSurface reflector and resulting ray trace simulation

Automotive high beam reflectors may be designed with procedural surfaces. In Figure 11, a wave structure gives the reflector an interesting styling feature.

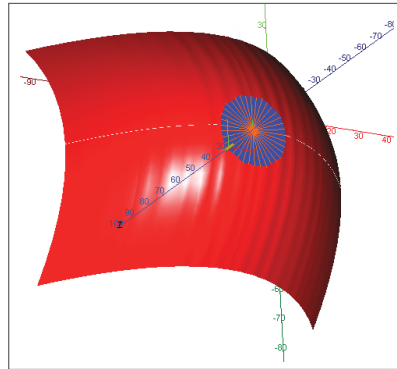

Figure 11: High beam reflector

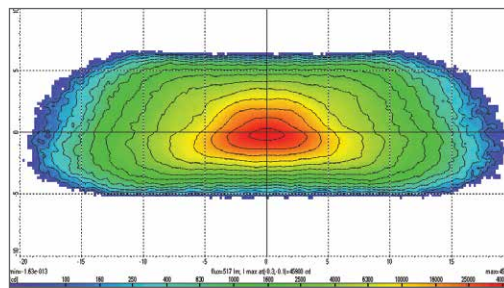

Figure 12: High beam reflector's resulting ray trace simulation

Procedural surfaces allow a wide range of styling approaches. For example, spread profiles may be formed like pillows or convex/concave as a wave structure. The overall polar grid may get a drill effect.

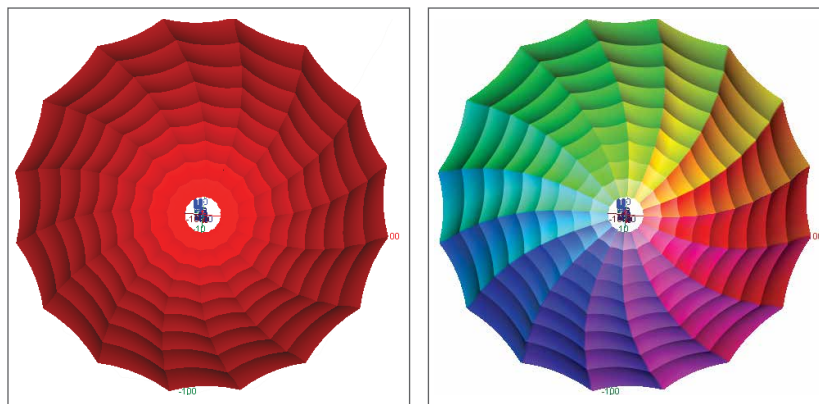

Figure 13: Styling feature with swung surface

## Profile Surfaces

You can also create a surface from a matrix of profile patches. The whole profile surface's mathematical representation is that of a NURBS surface, which makes it easy to use in a subsequent phase of CAD post processing. For each patch, a different lighting feature—either reflective or refractive—may be specified. A family of profile elements provides many types of lighting function:

- Freeform spread patches can be patches for cutoff beam patterns
- Simple patches, which use a pair of the profile curve elements for a vertical and horizontal light direction
- Simple spread patches over four corner light direction angles
- 3D prisms and TIR prisms
- Utility patches, which provide connection between other surfaces

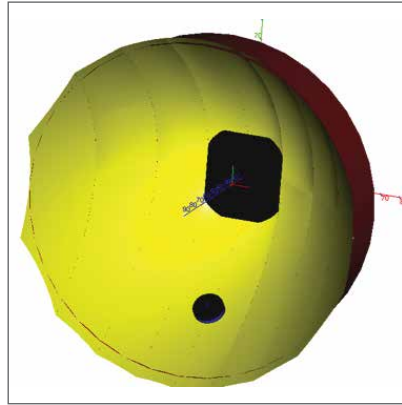

Figure 14: Profile surface with freeform patches

## Conclusion

A rich set of light design tools is the driving power for innovative design work. New lighting ideas and challenges also open up new demands for software to extend an engineer's tool box. In this manner, our design software grows over the years along with the daily project work. Real hardware-measured lighting results can be compared with the simulation results in order to refine the analyzing process.

For more information or to start your free 30-day evaluation, please contact Synopsys' Optical Solutions Group at (626) 795-9101, visit [synopsys.com/optical-solutions/lucidshape.html](http://synopsys.com/optical-solutions/lucidshape.html) or send an email to [optics@synopsys.com](mailto:optics@synopsys.com).